

Work happily



V1.2

naggura'swop

naggura.com

Our products



Massage

Swop 2L Massage

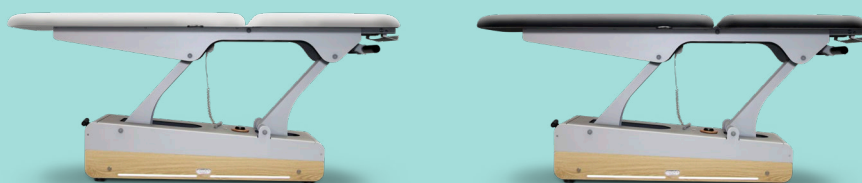

Swop 2L Massage is an all-round
electrical treatment table!
Simply multipurpose!

Wood, Metal or Pmma



Collections

Nordic METAL

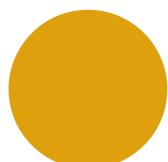

Yellow

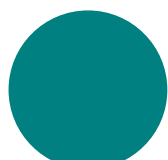

Blue

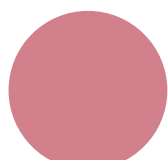

Pink

Foll METAL

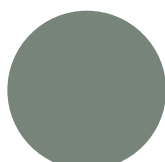

Ash

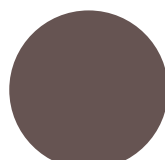

Clay

Iron METAL

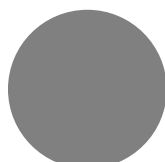

Inox

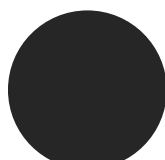

Black

Om WOOD



Oak



Wenge

Techno PMMA



Fluor



Fuxia



Ice

SWOP 2L MASSAGE



Dimensions

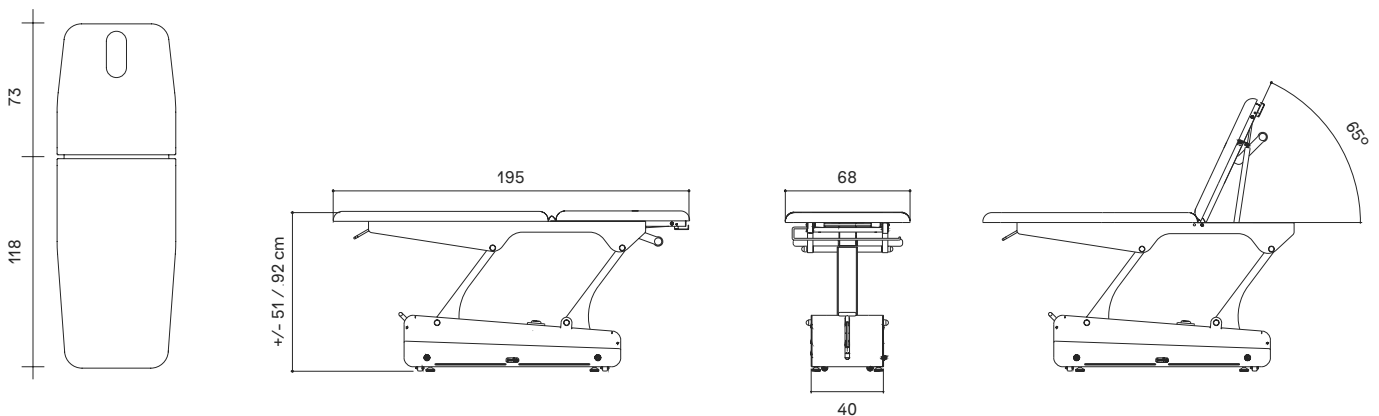

General Specifications

MOTORS

1 engine (height)

DIMENSIONS (LENGTH X WIDTH)

195 x 68 cm

HEIGHT (MIN. AND MAX.)

51/92 cm

WEIGHT

92 kg

THICKNESS

6 cm

DENSITY

40 kg/m³

LIFTING CAPACITY

200 kg

OPERATION

Hand controller (included)/
Foot controller (optional)

POWER SUPPLY

230 V - 50/60 Hz

MAX. INTENSITY

2 A

ELECTRIC MOTOR

6.000 N

CUSHION

Seamless Upholstery and round edges.

Naggura Skin upholstery:
100% vinyl compound in white or grey.

Superior abrasion resistance: >250.000 cycles.
Protection against germs and UV rays.

Nuestros Productos

Massage

Swop 2L Massage

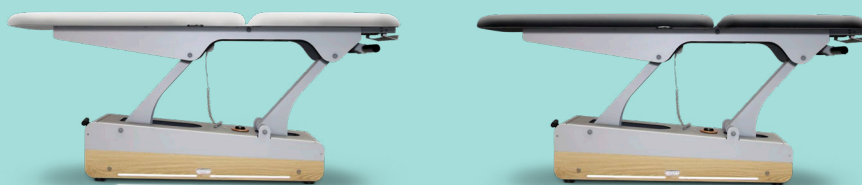

Swop 2L Massage es una camilla eléctrica todoterreno y polivalente.

Madera, metal o PMMA



Colecciones

Nordic METAL

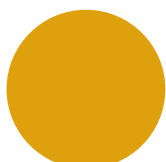

Yellow

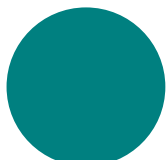

Blue

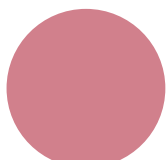

Pink

Foll METAL

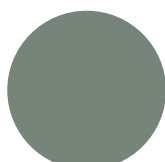

Ash

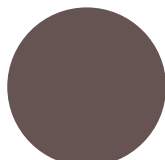

Clay

Iron METAL

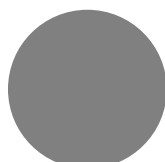

Inox

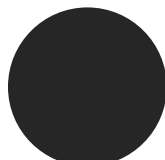

Black

Om MADERA



Oak



Wenge

Techno PMMA



Fluor

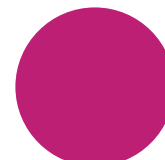

Fuxia



Ice

SWOP 2L MASSAGE



Dimensiones

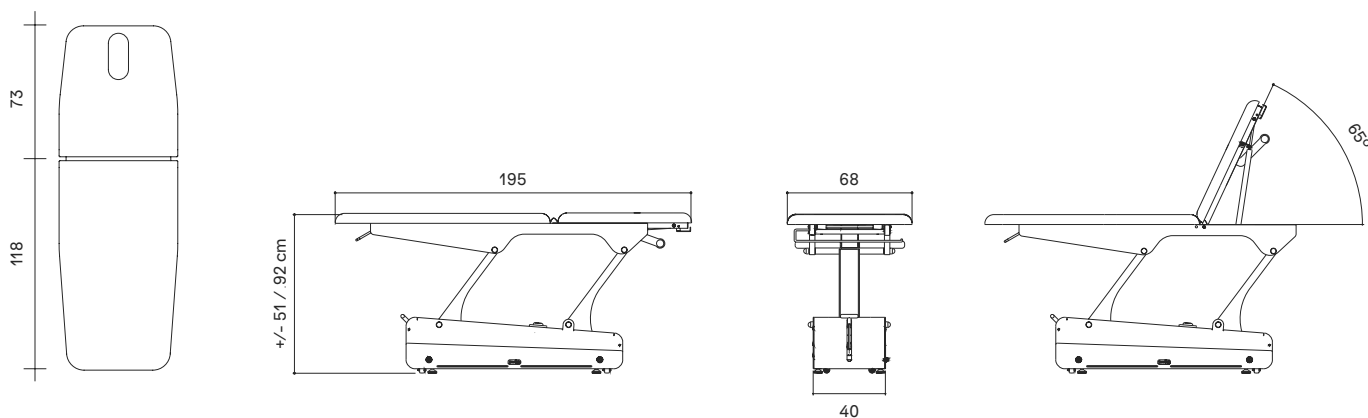

Características técnicas

MOTORES
1 motor (altura)

DIMENSIONES (LARGO X ANCHO)
195 x 68 cm

ALTURA (MIN. Y MAX.)
51/92 cm

PESO
92 kg

ESPESOR
6 cm

DENSIDAD
40 kg/m³

CAPACIDAD DE CARGA
200 kg

FUNCIONAMIENTO
Mando (incluido)/ Pedal
(opcional)

FUENTE DE ALIMENTACIÓN
230 V - 50/60 Hz

POTENCIA MÁXIMA
2 A

MOTOR ELÉCTRICO
6.000 N

TAPIZADO

Tapizado sin costuras y con bordes redondeados.

Tapizado con Naggura Skin: 100% Mezcla de vinilo en blanco o gris.

Resistencia a la abrasión: >250.000 ciclos. Protección contra gérmenes y rayos UV.

I nostri prodotti



Massage

Swop 2L Massage

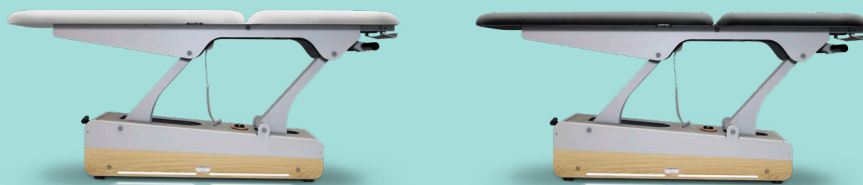

Swop 2L Massage è un lettino elettrico fuorilegge!
Semplicemente versatile!

Legno, metallo o PMMA



Collezioni

Nordic METALLO

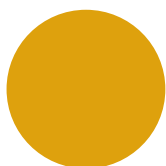

Yellow

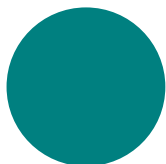

Blue

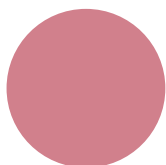

Pink

Foll METALLO



Ash

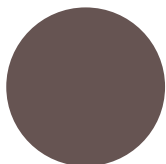

Clay

Iron METALLO

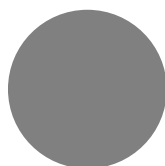

Inox

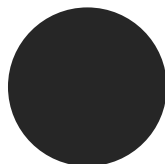

Black

Om LEGNO



Oak



Wenge

Techno PMMA



Fluor

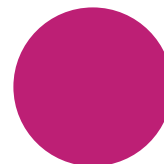

Fuxia



Ice

SWOP 2L MASSAGE



Dimensioni

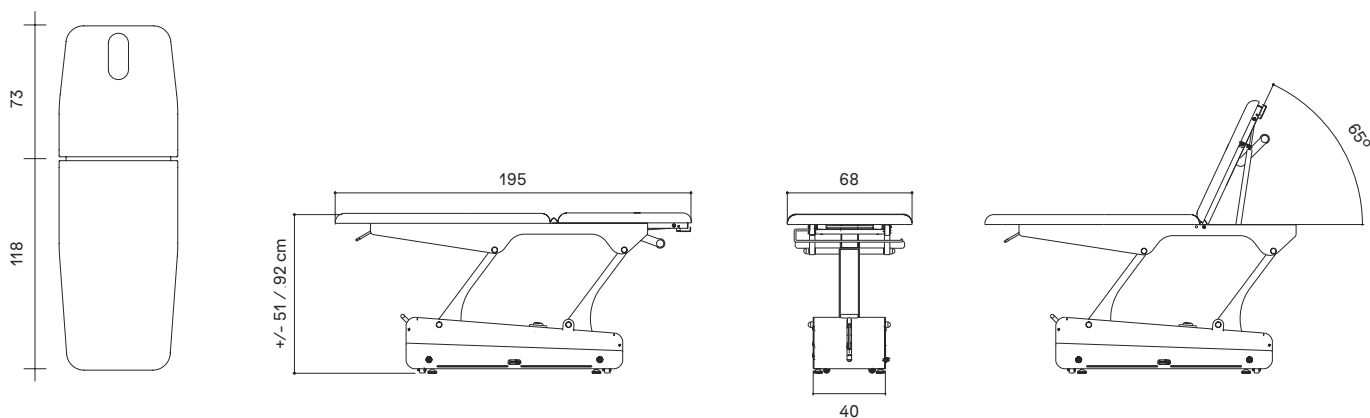

Caratteristiche tecniche

MOTORI

1 motore (altezza)

DIMENSIONI (LUNGHEZZA X LARGHEZZA)

195 x 68 cm

ALTEZZA (MINIMA E MASSIMA)

51/92 cm

PESO

92 kg

SPESSORE

6 cm

DENSITÀ

40 kg/m³

CAPACITÀ DI CARICO

200 kg

FUNZIONAMENTO

Telecomando (incluso)/
Pedaliera (opzionale)

ALIMENTAZIONE ELETTRICA

230 V - 50/60 Hz

POTENZA MASSIMA

2 A

MOTORE ELETTRICO

6.000 N

RIVESTIMENTO

Rivestimento senza cuciture con bordi arrotondati.

Rivestimento Naggura Skin: 100% Mix vinilico in bianco o grigio.

Resistenza all'abrasione: >250.000 cicli. Protezione contro germi e raggi UV.

Nos produits



Massage

Swop 2L Massage

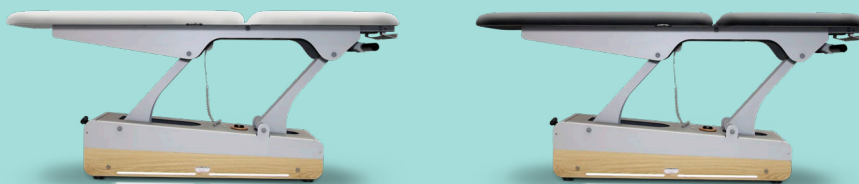

Swop 2L Massage est une table de traitement électrique complètement polyvalente!

Bois, Métal ou PMMA



Collections

Nordic MÉTAL

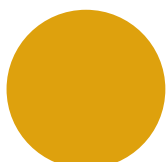

Yellow



Blue

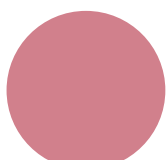

Pink

Foll MÉTAL

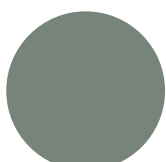

Ash

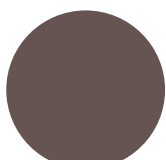

Clay

Iron MÉTAL

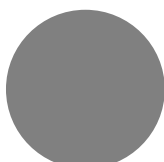

Inox

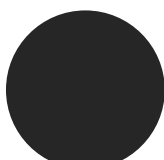

Black

Om BOIS



Oak



Wenge

Techno PMMA



Fluor



Fuxia



Ice

SWOP 2L MASSAGE



Dimensions

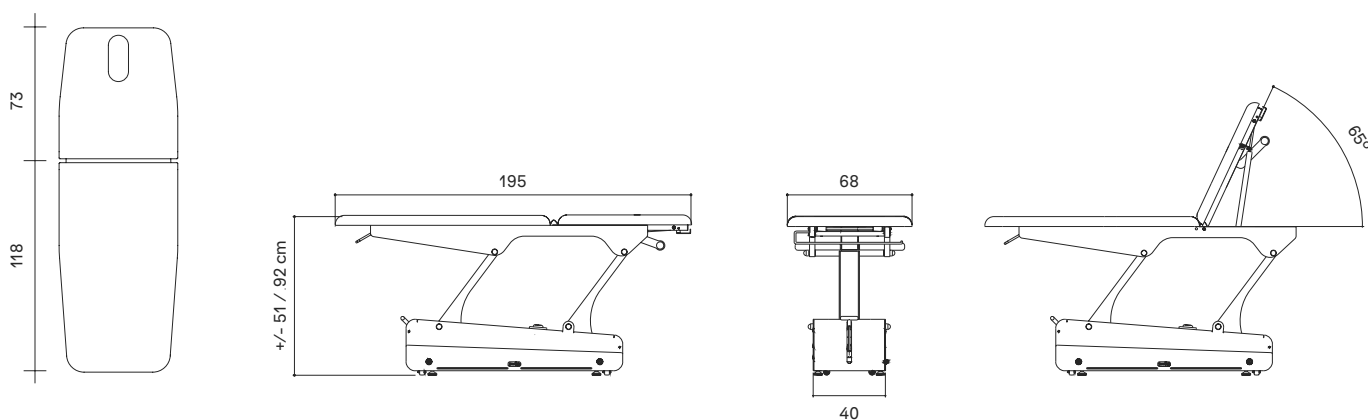

Spécifications Générales

MOTEURS

1 moteur (hauteur)

DIMENSIONS (LONGUEUR X LARGEUR)

195 x 68 cm

HAUTEUR (MIN. ET MAX.)

51/92 cm

POIDS

92 kg

ÉPAISSEUR

6 cm

DENSITÉ

40 kg/m³

CAPACITÉ DE CHARGE

200 kg

FONCTIONNEMENT

Télécommande à main (comprise)/Commande à pied (option)

ALIMENTATION

230 V - 50/60 Hz

INTENSITÉ MAX.

2 A

VÉRIN ÉLECTRIQUE

6.000 N

MATELAS

Revêtement sans coutures et bords arrondis.

Revêtement avec Naggura Skin : 100% composé de vinyle en blanc ou gris.

Résistance à l'abrasion : >250.000 cycles. Protection contre germes et rayons UV.

Unsere Produkte



Massage

Swop 2L Massage

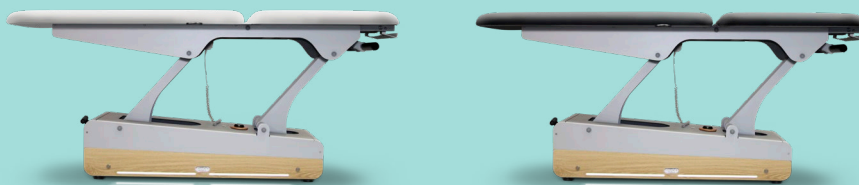

Swop 2L Massage ist eine multifunktionale, elektrische Behandlungsliege breit einsetzbar.

Holz, Metall oder PMMA



Kollektionen

Nordic METALL

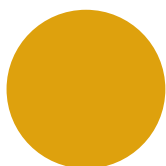

Yellow

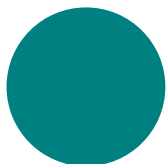

Blue

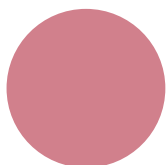

Pink

Foll METALL

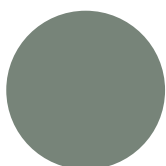

Ash

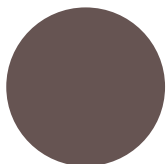

Clay

Iron METALL

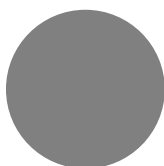

Inox

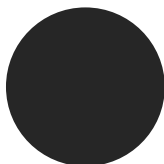

Black

Om HOLZ



Oak



Wenge

Techno PMMA



Fluor

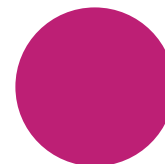

Fuxia



Ice

SWOP 2L MASSAGE



Abmessungen

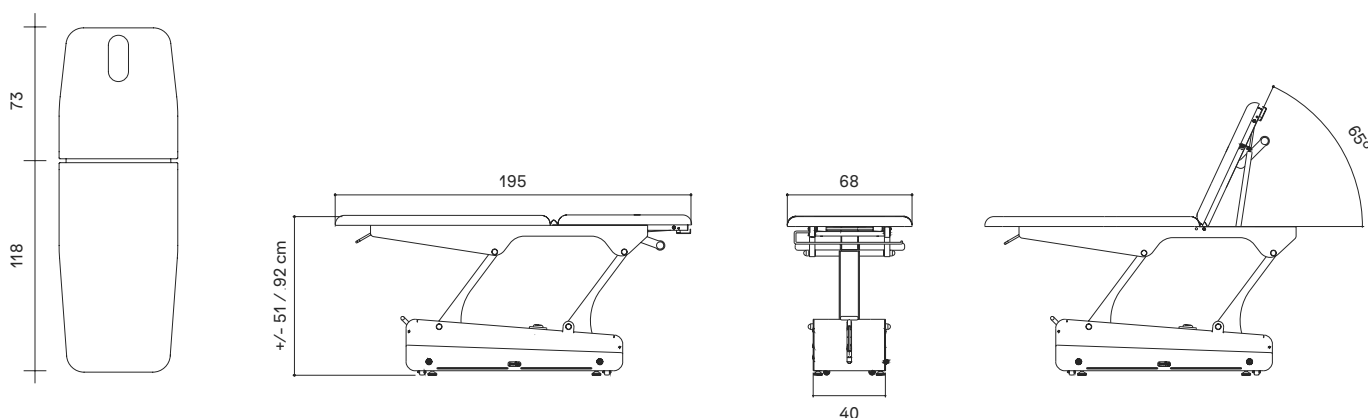

Technische Angaben

MOTOREN
1 Motor (Höhe)

ABMESSUNGEN (LÄNGE X BREITE)
195 x 68 cm

HÖHE (MIN. UND MAX.)
51/92 cm

GEWICHT
92 kg

POLSTERDICKE
6 cm

DICHTE
40 kg/m³

BELASTBARKEIT
200 kg

BEDIENUNG
Handfernbedienung (serien-
mäßige Ausstattung)/
Fußfernbedienung (optional)

STROMVERSORGUNG
230 V - 50/60 Hz

MAX. INTENSITÄT
2 A

ELEKTRISCHER MOTOR
6.000 N

POLSTERUNG

Nahtloser Polsterbezug und
mit abgerundeten Kanten.

Nagura Skin Polsterbezug:
100 % Vinyl-Mischung in
Weiß oder Grau.

Abriebfestigkeit: >250.000
Zyklen. Schutz vor Keimen
und UV-Strahlen.

Onze producten



Massage

Swop 2L Massage

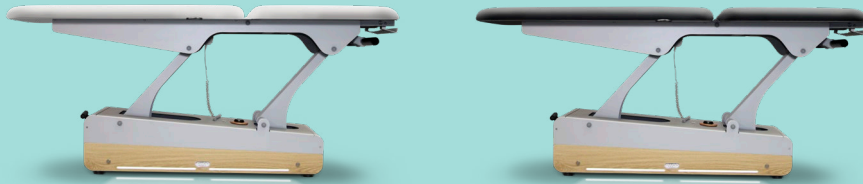

De Swop 2L Massage is een all-round 2-delige elektrische tafel met lang instelbaar rugdeel. De tafel is uitermate geschikt voor behandelingen en onderzoeken.

Hout, metaal of Pmma



Collectie paneeltjes

Nordic METAAL

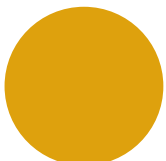

Yellow

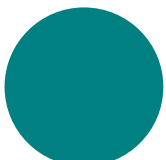

Blue

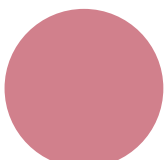

Pink

Foll METAAL



Ash

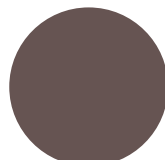

Clay

Iron METAAL

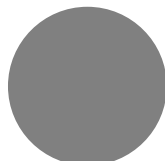

Inox

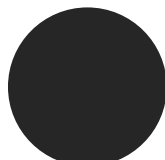

Black

Om HOUT



Oak



Wenge

Techno PMMA



Fluor

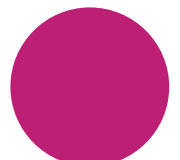

Fuxia



Ice

SWOP 2L MASSAGE



Afmetingen en instelmogelijkheden

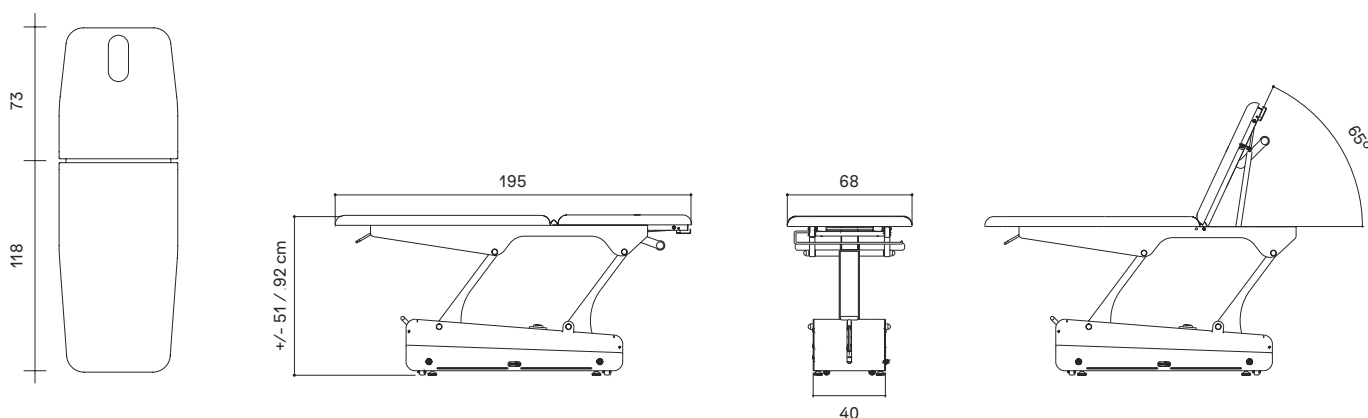

Algemene Specificaties

MOTOREN

1 Motor (hoogte)

AFMETINGEN (LENGTE-BREEDTE)

195 x 68 cm

HOOGTE (MIN. AND MAX.)

51/92 cm

GEWICHT

92 kg

DIKTE KUSSENS

6 cm

POLSTERING

40 kg/m³

MAXIMALE DYNAMISCHE BELASTING

200 kg

BEDIENING

Handschakelaar (inbegrepen)/ Voetschakelaar (optioneel)

STROOMVOORZIENING

230 V - 50/60 Hz

MAX. INTENSITEIT STROOMOPNAME

2 A

ELEKTRISCHE MOTOR HOOG/LAAG

6.000 N

BEKLEDING

De Kussens zijn naadloos en hebben afgeronde hoeken.

Naggura Skin bekleding: 100% vinyl samenstelling in wit of graphite.

Een slijtvastheid van het kunstleer is maar liefst 250K en beschermt tegen bacteriën en UV stralen.