

Work happily



V1.3

naggura'swop

naggura.com

Our products

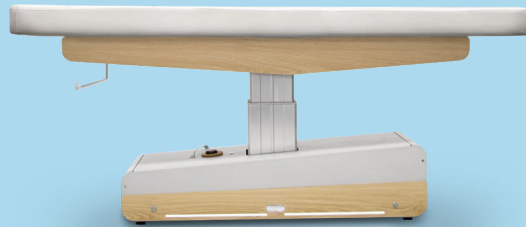

The Swop S3 Starter Spa is an electrical 3-section table with a one-piece mattress and wooden structure.

Wood, Metal or Pmma



Collections

Nordic
METAL

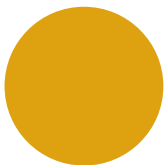

Yellow

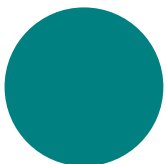

Blue

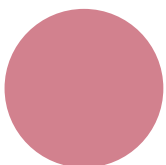

Pink

Foll
METAL



Ash

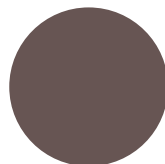

Clay

Iron
METAL

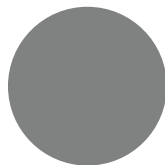

Inox

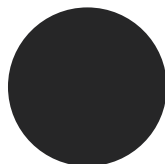

Black

Om
WOOD



Oak



Wenge

Techno
PMMA



Fluor

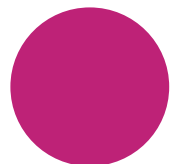

Fuxia



Ice

SWOP S3 STARTER SPA



Dimensions

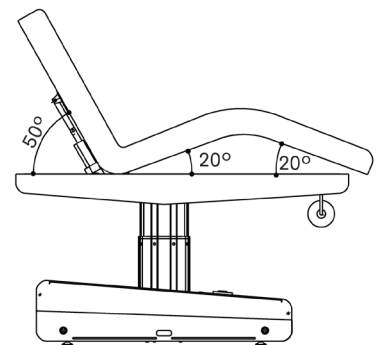
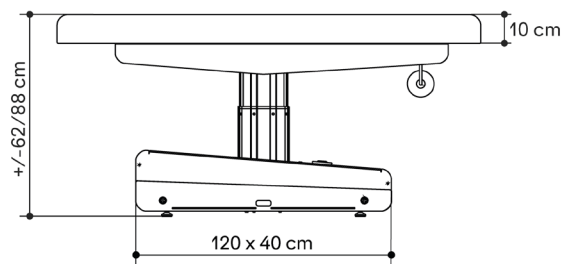

General specifications

MOTORS
3 engine (height, footrest, backrest)

DIMENSIONS (LENGTH X WIDTH)
200 x 75 cm

HEIGHT (MIN. AND MAX.)
62/88 cm

WEIGHT
110 kg

THICKNESS
10 cm

DENSITY
30 kg/m³

LIFTING CAPACITY
175 kg

OPERATION
Hand controller (included)/
Foot controller (optional)

POWER SUPPLY
230 V - 50/60 Hz

MAX. INTENSITY
2 A

ELECTRIC MOTOR
6.000 N

WARRANTY
2 years on table and
upholstery

CUSHION

Upholstery Seamless
round edges.

Naggura Skin upholstery:
100% vinyl compound in
white.

Superior abrasion resis-
tance: >250.000 cycles.
Protection against germs
and UV rays.

Nuestros Productos

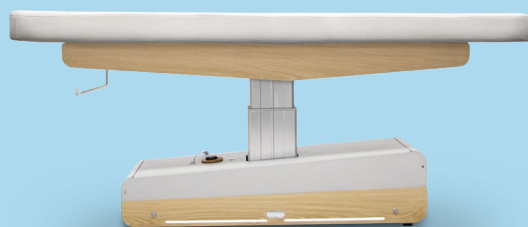

Swop S3 Starter Spa es una camilla eléctrica de 3 secciones con colchón continuo y revestimiento de madera.

Madera, metal o PMMA



Colecciones

Nordic
METAL

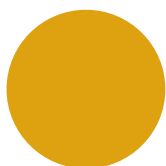

Yellow

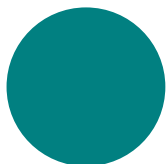

Blue

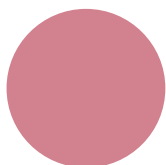

Pink

Foll
METAL



Ash

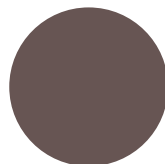

Clay

Iron
METAL

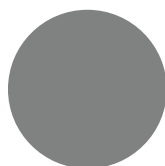

Inox

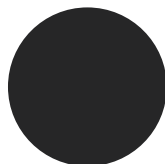

Black

Om
MADERA



Oak



Wenge

Techno
PMMA



Fluor

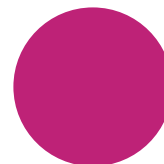

Fuxia



Ice

SWOP S3 STARTER SPA



Dimensiones

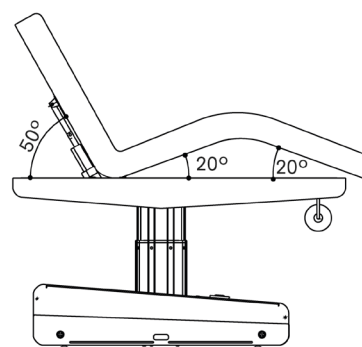
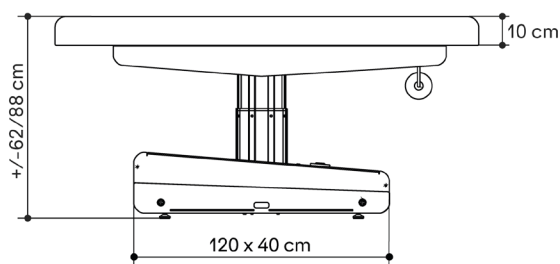
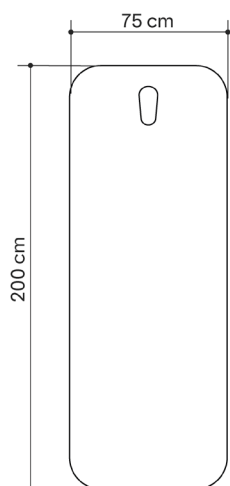

Características técnicas

MOTORES

3 motores (altura, inclinación respaldo y reposapiés)

DIMENSIONES (LARGO X ANCHO)

200 x 75 cm

ALTURA (MÍNIMA Y MÁXIMA)

62/88 cm

PESO

110 kg

ESPESOR

10 cm

DENSIDAD

30 kg/m³

CAPACIDAD DE CARGA

175 kg

FUNCIONAMIENTO

Mando (incluido)/ Pedal (opcional)

FUENTE DE ALIMENTACIÓN

230 V - 50/60 Hz

POTENCIA MÁXIMA

2 A

MOTOR ELÉCTRICO

6.000 N

GARANTÍA

2 años (camilla y tapizado)

TAPIZADO

Tapizado sin costuras y con bordes redondeados.

Tapizado con Naggura Skin: 100% Mezcla de vinilo en blanco.

Resistencia a la abrasión: >250.000 ciclos. Protección contra gérmenes y rayos UV.

I nostri prodotti



Spa

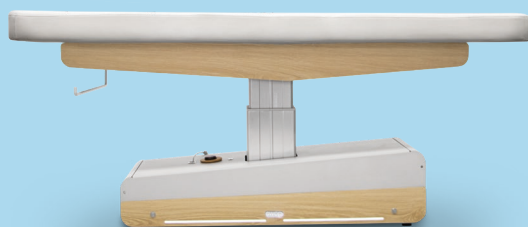

Swop S3 Starter Spa è un lettino elettrico a 3 sezioni con materasso tutto d'un pezzo e rivestimento in legno.

Legno, metallo o PMMA



Collezioni

Nordic
METALLO

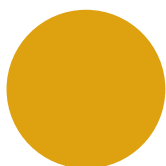

Yellow

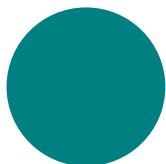

Blue

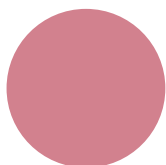

Pink

Foll
METALLO



Ash

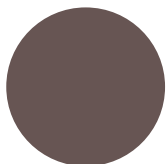

Clay

Iron
METALLO

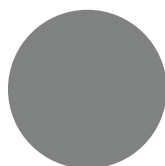

Inox

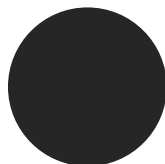

Black

Om
LEGNO



Oak



Wenge

Techno
PMMA



Fluor

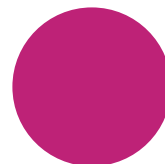

Fuxia



Ice

SWOP S3 STARTER SPA



Dimensioni

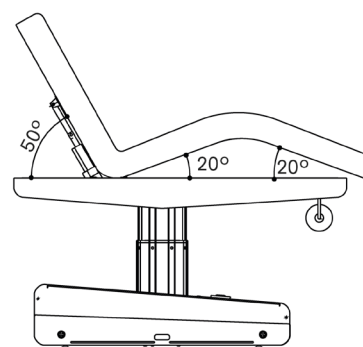
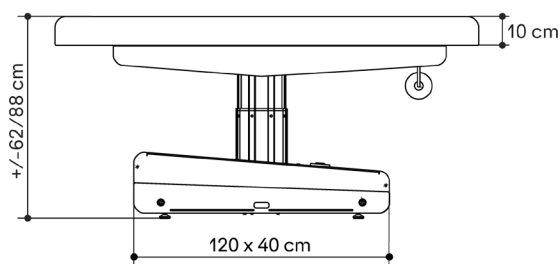
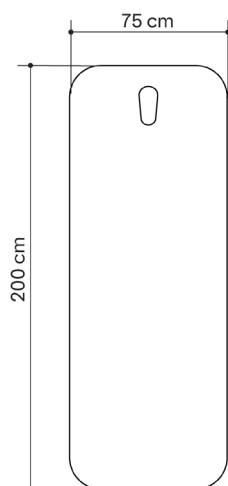

Caratteristiche tecniche

MOTORI

3 motori (altezza, inclinazione schienale e poggiatesta)

DIMENSIONI (LUNGHEZZA X LARGHEZZA)

200 x 75 cm

ALTEZZA (MINIMA E MASSIMA)

62/88 cm

PESO

110 kg

SPESSORE

10 cm

DENSITÀ

30 kg/m³

CAPACITÀ DI CARICO

175 kg

FUNZIONAMENTO

Telecomando (incluso)/
Pedaliera (opzionale)

ALIMENTAZIONE ELETTRICA

230 V - 50/60 Hz

POTENZA MASSIMA

2 A

MOTORE ELETTRICO

6.000 N

GARANZIA

2 anni sul lettino e il rivestimento

RIVESTIMENTO

Rivestimento senza cuciture con bordi arrotondati.

Rivestimento Naggura Skin: 100% Mix vinilico in bianco.

Resistenza all'abrasione: >250.000 cicli. Protezione contro germi e raggi UV.

Nos produits

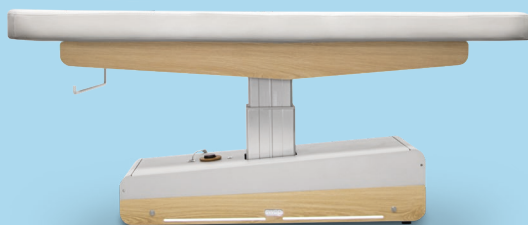

La table Swop S3 Starter Spa est une table électrique à 3 sections avec matelas monobloc et structure en métal et bois.

Bois, Métal ou PMMA



Collections

Nordic
MÉTAL

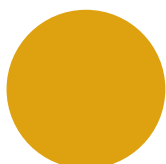

Yellow

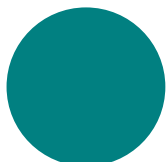

Blue

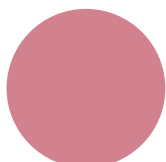

Pink

Foll
MÉTAL

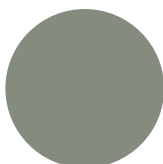

Ash

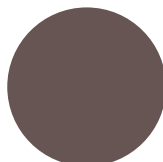

Clay

Iron
MÉTAL

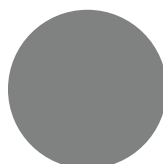

Inox

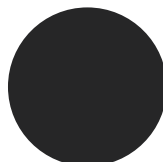

Black

Om
BOIS



Oak



Wenge

Techno
PMMA



Fluor

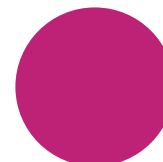

Fuxia



Ice

SWOP S3 STARTER SPA



Dimensions

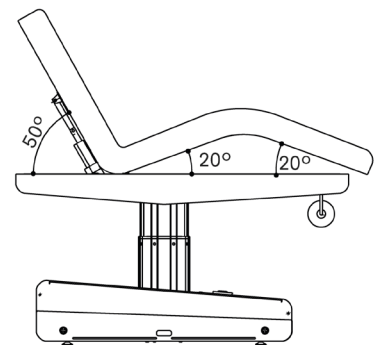
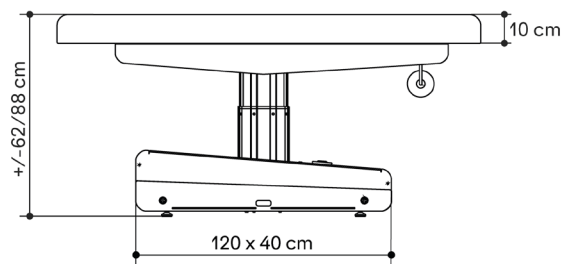

Spécifications Générales

MOTEURS

3 moteurs (hauteur, repose-pieds, dossier)

DIMENSIONS (LONGUEUR X LARGEUR)

200 x 75 cm

HAUTEUR (MIN. ET MAX.)

62/88 cm

POIDS

110 kg

ÉPAISSEUR

10 cm

DENSITÉ

30 kg/m³

CAPACITÉ DE CHARGE

175 kg

FONCTIONNEMENT

Télécommande à main (comprise)/Commande à pied (option)

ALIMENTATION

230 V - 50/60 Hz

INTENSITÉ MAX.

2 A

VÉRIN ÉLECTRIQUE

6.000 N

GARANTIE

2 ans sur la table et le revêtement

MATELAS

Revêtement sans coutures et bords arrondis.

Revêtement avec Naggura Skin : 100% composé de vinyle en blanc.

Résistance à l'abrasion : >250.000 cycles. Protection contre germes et rayons UV.

Unsere Produkte



Spa



Swop S3 Starter Spa ist eine dreiteilige elektrische Liege mit einer einteiligen Matratze und Verkleidung aus Holz.

Holz, Metall oder PMMA



Kollektionen

Nordic
METALL

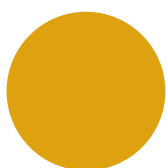

Yellow

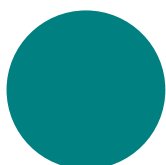

Blue

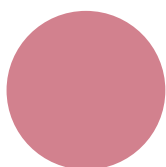

Pink

Foll
METALL

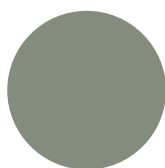

Ash

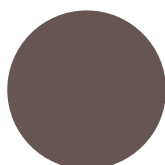

Clay

Iron
METALL

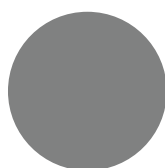

Inox

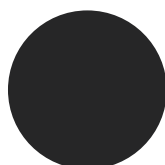

Black

Om
HOLZ



Oak



Wenge

Techno
PMMA



Fluor

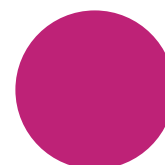

Fuxia



Ice

SWOP S3 STARTER SPA



Abmessungen

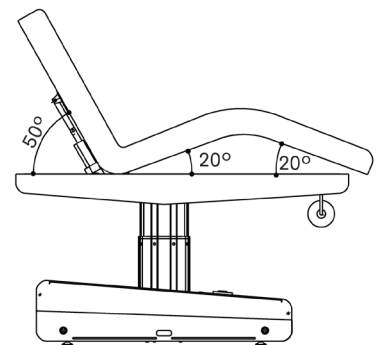
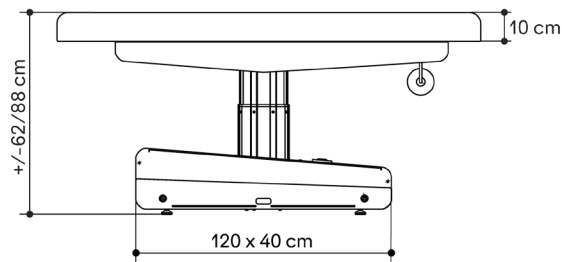
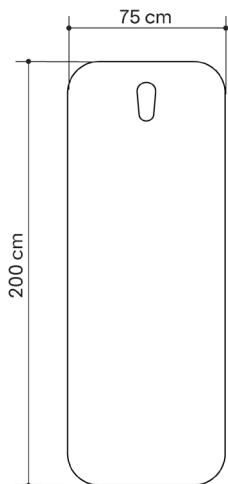

Technische Angaben

MOTOREN

3 Motoren (Höhe, Rückenlehne und Beinteil)

ABMESSUNGEN (LÄNGE X BREITE)

200 x 75 cm

HÖHE (MIN. UND MAX.)

62/88 cm

GEWICHT

110 kg

POLSTERDICKE

10 cm

DICHTE

30 kg/m³

BELASTBARKEIT

175 kg

BEDIENUNG

Handfernbedienung (serienmäßige Ausstattung)/
Fußfernbedienung (optional)

STROMVERSORUNG

230 V - 50/60 Hz

MAX. INTENSITÄT

2 A

ELEKTRISCHER MOTOR

6.000 N

GARANTIE

2 Jahre auch auf Polsterbezug

POLSTERUNG

Nahtloser Polsterbezug und mit abgerundeten Kanten.

Naggura Skin Polsterbezug: 100 % Vinyl-Mischung in Weiß.

Abriebfestigkeit: >250.000 Zyklen. Schutz vor Keimen und UV-Strahlen.

Onze producten



De Swop S3 Starter Spa is een 3-delige massage en wellness tafel met 3 motoren, een matras uit één stuk en houten bekleding.

Hout, Metaal of Pmma



Collectie paneeltjes

Nordic
METAAL

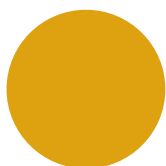

Yellow

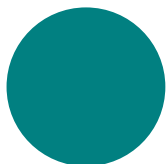

Blue

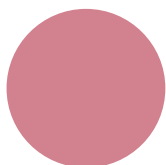

Pink

Foll
METAAL

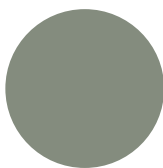

Ash

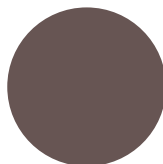

Clay

Iron
METAAL

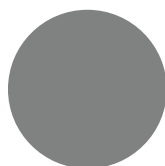

Inox

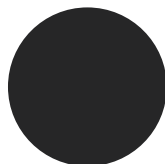

Black

Om
HOUT



Oak



Wenge

Techno
PMMA



Fluor

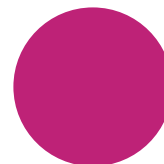

Fuxia



Ice

SWOP S3 STARTER SPA



Afmetingen en instelmogelijkheden

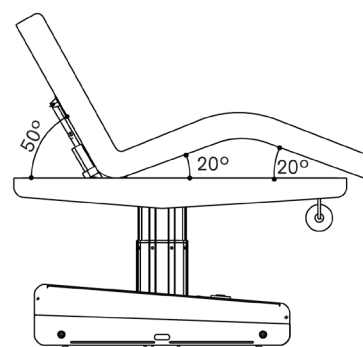
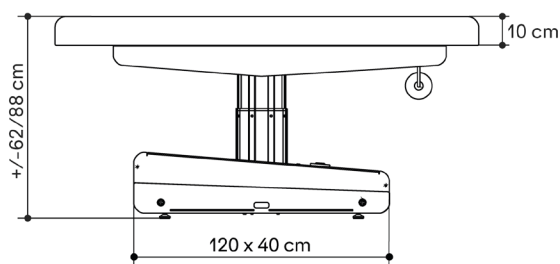
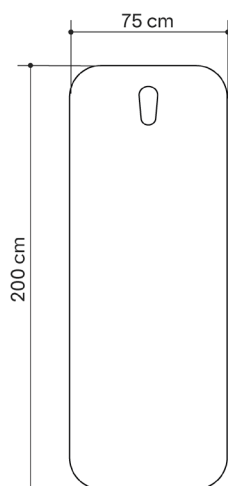

Algemene Specificaties

MOTOREN

3 motoren (hoogte, beendeel, rugleuning)

AFMETINGEN (LENGTE-BREEDTE)

200 x 75 cm

HOOGTE (MIN. AND MAX.)

62/88 cm

GEWICHT

110 kg

GARANTIE

3 jaar op bank en kunstleer

DIKTE KUSSENS

10 cm

POLSTERING

30 kg/m³ (zeer zacht)

MAXIMALE DYNAMISCHE BELASTING

175 kg

BEDIENING

Handschakelaar (inbegrepen)/ Voetschakelaar (optioneel)

STROOMVOORZIENING

230 V - 50/60 Hz

MAX. STROOMOPNAME

2 A

ELEKTRISCHE MOTOR HOOG/LAAG

6.000 N

STANDAARD TOEBEHOREN

Setje houten paneeltjes:
OAK
Papierrolhouder

BEKLEDING

Kussens uit één geheel, perfect te reinigen.

Naggura Skin bekleding: 100% vinyl samenstelling in wit.

Een slijtvastheid van het kunstleer is maar liefst 250K en beschermt tegen bacteriën en UV stralen.